

Article number: 203080M16125A1U

Description: E+G levelling foot
GN 30-80-M16-125-A1-U

Note: U Without nut, Hexagon socket at the top, Wrench flat at the bottom

Measures

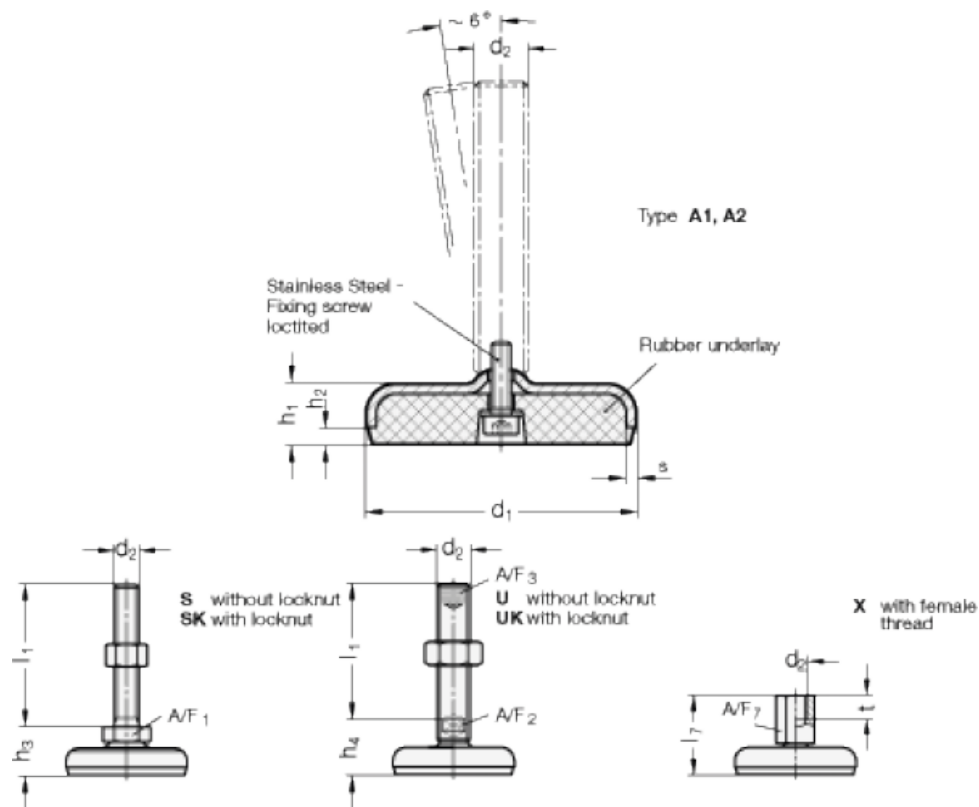

A/F2 = 12

s = 3

A/F3 = 8

d1 = 80

d2 = M16

h1 = 18

h2 = 5

h4 = 32

l1 = 125